

Current-compensated chokes



- Rated currents from 6 to 64A
- Up to 600VAC or 850VDC
- DC to 400Hz frequencies
- Dual, triple and quad-choke configurations



Technical specifications

Maximum continuous operating voltage:	600VAC/850VDC @ 40°C
Operating frequency:	dc to 400Hz
Rated currents:	6 to 64A @ 40°C max.
High potential test voltage winding-to-winding @ 25°C:	2500VAC, 60 sec, guaranteed 2500V, 50Hz, 2 sec, factory test
winding-to-housing @ 25°C:	4000VAC, 60 sec, guaranteed
Surge current @ 10msec:	20 x I _{nominal} @ 25°C
Temperature range (operation and storage):	-25°C to +110°C (25/110/21)
Flammability corresponding to:	UL 94V-0 (insulation tubes UL 94V-2)
MTBF @ 40°C/230V (Mil-HB-217F):	> 5,000,000 hours

Typical electrical schematic

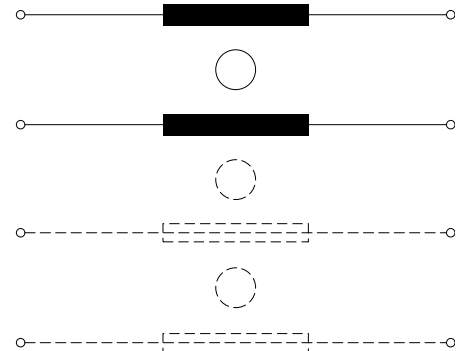

RD chokes are attenuating common-mode or asymmetric (P/N → E) interference signals, by being connected in series with the phase and neutral lines of an AC powerline input. Symmetrical components of the noise are also attenuated by the leakage inductance of the windings. These chokes are typically used in conjunction with suppression capacitors.

Features and benefits

- High saturation resistance and excellent thermal behavior.
- Through hole or wire connections.
- Dual, triple and quad-choke configuration.
- Up to 64A quad configuration.
- Multiple housing options.
- Custom-specific versions are available on request.

Typical applications

- Phase-angle control circuits in combination with saturating chokes
- EMI input filters
- For suppressing equipment with no earth connection
- Suppressing high interference levels

Choke selection table

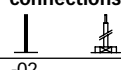
Choke	Nominal current @ 40°C	Inductance L [mH/path]	Resistance R [mΩ/path]	Choke configuration [Qty]	Input/Output connections 	Pin footprint [mm]	Weight [g]
	[A]						
RD 5122-6-9m6	6	9.6	52.55	2	-02	Ø1	160
RD 5122-10-6m0	10	6	24.25	2	-02	Ø1.3	160
RD 5122-16-2m0	16	2	9.5	2	-02	Ø1.6	160
RD 5132-6-5m0	6	5	38	3	-02	Ø1	160
RD 5132-10-3m0	10	3	17.6	3	-02	Ø1.3	160
RD 5132-16-1m0	16	1	6.9	3	-02	Ø1.6	160
RD 6127-6-15m0	6	15	66.65	2	-07	Ø1	235
RD 6127-10-9m0	10	9	25.9	2	-07	Ø1.5	235
RD 6127-16-3m0	16	3	10.9	2	-07	Ø1.8	235
RD 6137-6-7m5	6	7.5	49	3	-07	Ø1	235
RD 6137-10-4m5	10	4.5	18.35	3	-07	Ø1.5	235
RD 6137-16-1m5	16	1.5	8.3	3	-07	Ø1.8	235
RD 7127-6-25m0	6	25	84.2	2	-07	Ø1	320
RD 7127-10-14m0	10	14	33.5	2	-07	Ø1.4	350
RD 7127-16-5m7	16	5.7	14.1	2	-07	Ø1.8	370
RD 7127-25-2m8	25	2.8	6.4	2	-07	Ø2.4	400
RD 7127-36-1m0	36	1	3.3	2	-07	Ø2.7	380
RD 7137-6-12m0	6	12	60.6	3	-07	Ø1	340
RD 7137-10-6m6	10	6.6	21.9	3	-07	Ø1.5	380
RD 7137-16-2m8	16	2.8	10.7	3	-07	Ø1.8	380
RD 7137-25-1m3	25	1.3	4.45	3	-07	Ø2.5	440
RD 7137-36-0m5	36	0.5	2.75	3	-07	Ø2.7	400
RD 7147-6-6m0	6	6	45.1	4	-07	Ø1	320
RD 7147-10-3m5	10	3.5	19.1	4	-07	Ø1.4	370
RD 7147-16-1m5	16	1.5	8.5	4	-07	Ø1.8	390
RD 7147-25-0m7	25	0.7	3.65	4	-07	Ø2.4	430
RD 7147-36-0m2	36	0.2	2.3	4	-07	Ø2.5	400
RD 8127-16-12m0	16	12	20.05	2	-07	Ø2	590
RD 8127-25-5m0	25	5	8.45	2	-07	Ø2.4	630
RD 8127-36-3m0	36	3	4.55	2	-07	1.5 x 4.5	690
RD 8127-50-1m0	50	1	2.5	2	-07	1.7 x 5	640
RD 8127-64-0m8	64	0.8	1.6	2	-07	2.5 x 5	710
RD 8137-16-5m0	16	5	11.6	3	-07	Ø2	630
RD 8137-25-2m5	25	2.5	6.4	3	-07	Ø2.4	650
RD 8137-36-1m5	36	1.5	3.65	3	-07	1.5 x 4.5	720
RD 8137-50-0m6	50	0.6	2.15	3	-07	1.7 x 5	700
RD 8137-64-0m5	64	0.5	1.35	3	-07	2.5 x 5	780
RD 8147-16-3m0	16	3	9.25	4	-07	Ø2	650
RD 8147-25-1m3	25	1.3	5.05	4	-07	Ø2.4	650
RD 8147-36-0m8	36	0.8	3	4	-07	1.5 x 4.5	760
RD 8147-50-0m3	50	0.3	1.75	4	-07	1.7 x 5	740
RD 8147-64-0m2	64	0.2	1.1	4	-07	2.5 x 5	820

Test conditions:

Measuring frequency: 1kHz; 500µA > 0.16mH > 1.6mH; 50µA > 1.6mH < 160mH

Inductance tolerance: +50%, -30%

Resistance tolerance: max. ±15% @ 25°C; 200mΩ, 100mA

Electrical characteristics @ 25°C: ±2°C

Typical choke attenuation/resonance frequency characteristics

Per CISPR 17; 50Ω/50Ω asym

RD 51x2

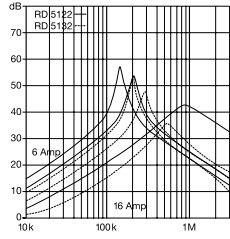

RD 61x7

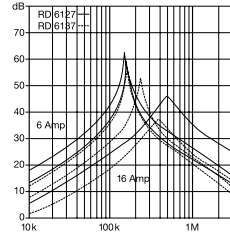

RD 7127

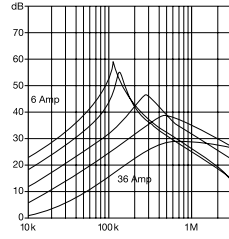

RD 7137

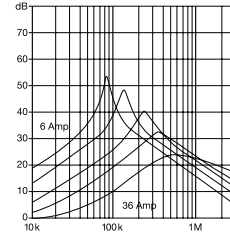

RD 7147

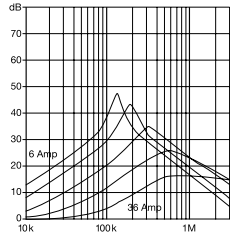

RD 8127

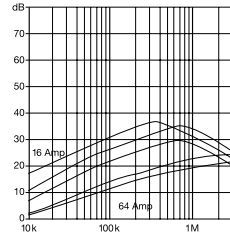

RD 8137

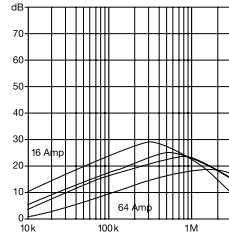

RD 8147

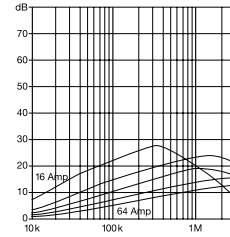

Typical saturation characteristics

Inductance (typical value in %) vs. nominal current (A DC)

RD 51x2

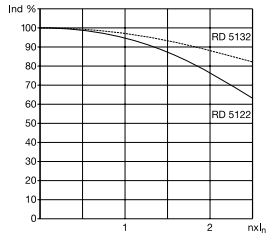

RD 61x7

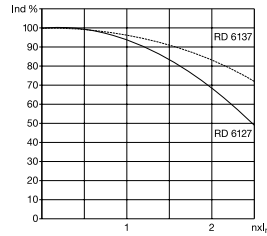

RD 71x7

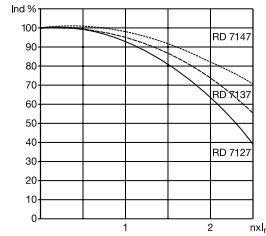

RD 81x7

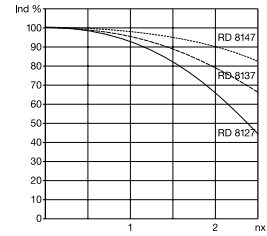

Mechanical data

RD 5122

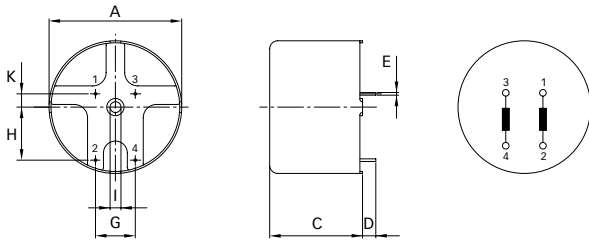

RD 5132

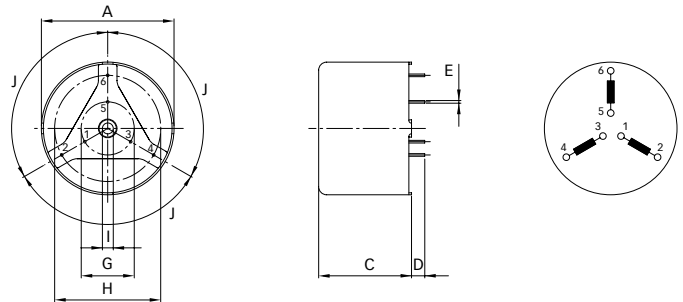

RD 6127, RD 7127, RD 8127

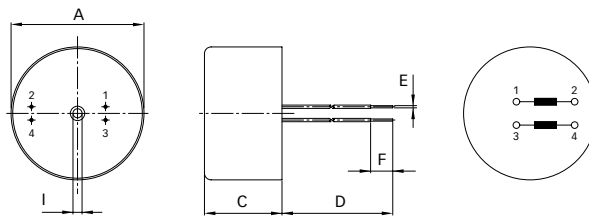

RD 6137, RD 7137, RD 8137

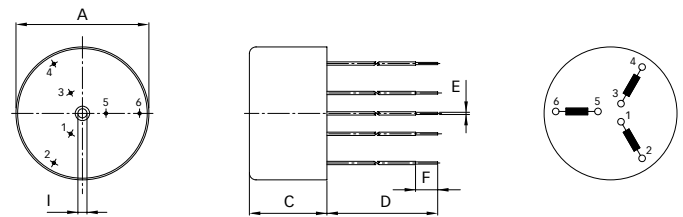

RD 7147, RD 8147

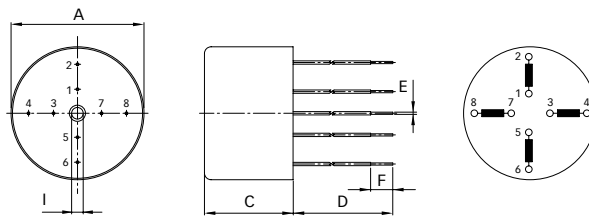

Dimensions

	RD 5122	RD 5132	RD 6127	RD 6137	RD 7127	RD 7137	RD 7147	RD 8127	RD 8137	RD 8147	Tolerances
A	50	50	60	60	70	70	70	80	80	80	±0.5
C	35	35	35	35	40	40	40	50	50	50	±0.5
D	5 ±0.5	5 ±0.5	150	150	150	150	150	200	200	200	+5/-0
E	see choke selection table										
F			10	10	10	10	10	20	20	20	±1
G	15	20									±0.3
H	20	40 ±0.4									±0.3
I	4.1 +3/-0	4.1 +3/-0	4.1 +3/-0	4.1 +3/-0	6.1	6.1	6.1	6.1	6.1	6.1	+6/-0
J		120°									
K	5										

All dimensions in mm; 1 inch = 25.4mm
Tolerances according: ISO 2768-m / EN 22768-m